

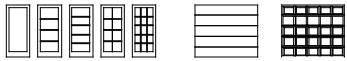

Door Type Styles

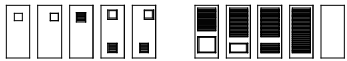

Door Swings

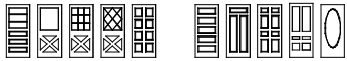
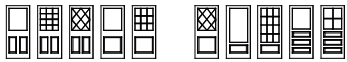

Door Panel Styles

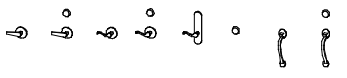
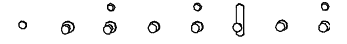

24 Door Handle Styles

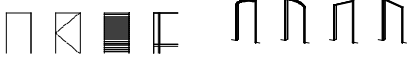
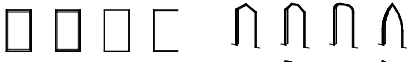

Customizable infills

Arch shapes



Window Styles



Skylights

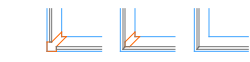

Curtainwall System



Operable doors and windows set the stage for capturing the feeling of reality. Clients will have a better understanding of the design when you show them 3D doors and windows operate just like their real counterparts.

Features:

- Eight new doors have many options including sidelights and transoms, arch shapes, single and double doors in one object, overhead doors with arches, multiple panel sliding doors, bifold, pocket, a surface sliding door for elevators and barns, and a folding door with a pocket option.
- Window types include stationary, awning, hopper, casement, double/triplehung, and glider.
- Window combinations include bay, bow, stack and picture.
- Opening shapes include two styles of full arches, partial arch, half arch, Gothic arch, gable, chamfer, fillet, triangle, trapezoid, polygon and full circle.
- Fully operable windows can be ganged limitlessly and can wrap around curved walls.
- Corner windows at any angle, either butt-glazed or mitered frame.
- Trim profiles from the Trim Mouldings library.
- Window 2D symbols can be turned off.
- 24 door handle styles
- Curtain wall system to work as window, door or as stand-alone object.
- Skylights: rectangular, dome, and pyramid.
- Integrated symbol marker with user-definable shape.
- Interior color different for door panels and window sashes.
- Door handles individually defined inside and out.
- Infills and panels include flat glass, raised panels, louvers, picture mapped (i.e. stained glass) and user created with a kit-of-parts.

CALL TOLL FREE

888.324.2003

Dimensions

Design Group Inc.

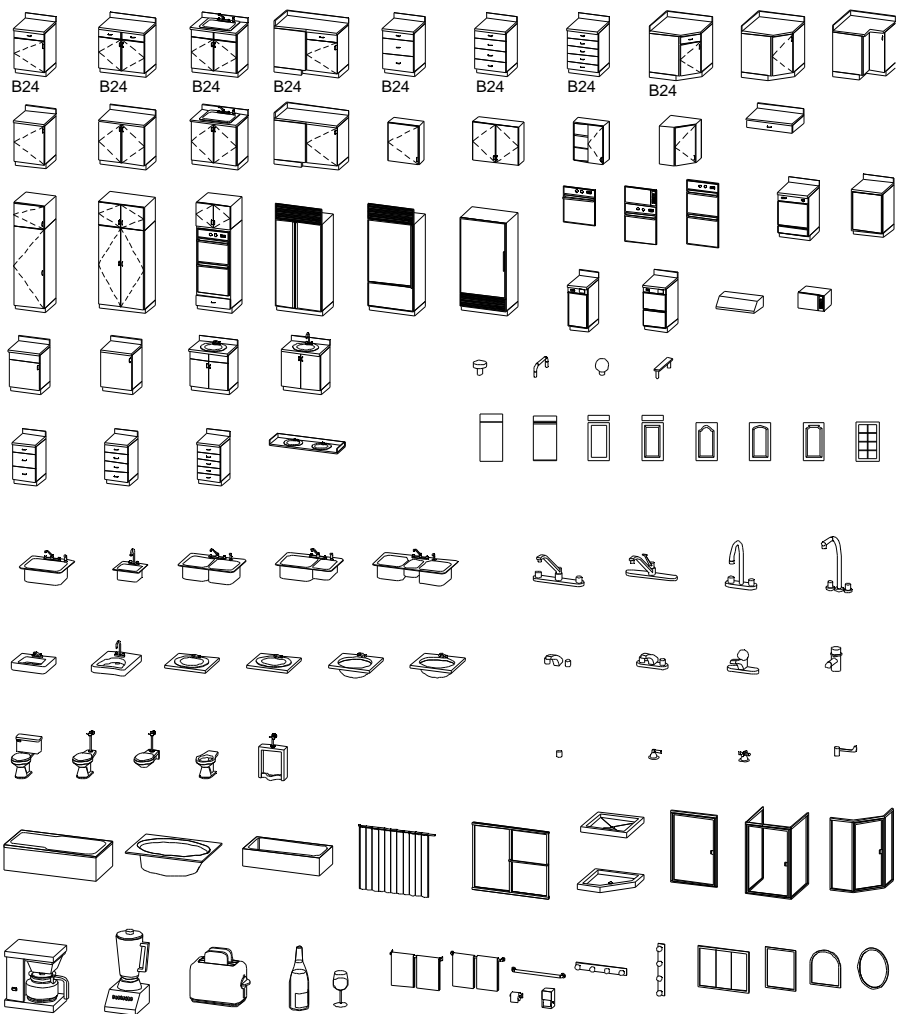
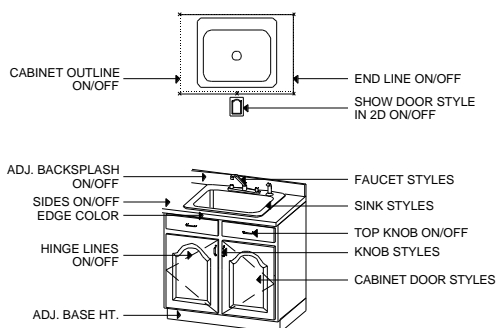

D3 SmartParts™ v3.0

Real Kitchen & Bath



With Real Kitchen & Bath you can select from dozens of cabinets, appliances and fixtures commonly used in residential, commercial and institutional projects. Test a variety of layouts to maximize a kitchen or bath project's potential.

Features:

- NEW highly configurable cabinets with integrated sink and faucet, multiple doors and drawers, customizable panels, knobs and handles
- NEW integrated countertop with seamless sides and back, adjustable overhang, independent edge color and adjustable backsplash, sidesplash
- NEW upscale appliances with matching panels and several options
- NEW wines rack and undercounter wine cooler with random bottles
- Corner cabinets, built-in oven cabinets, and specialty cabinets and whatnot shelves
- Match panels on appliances
- Customize doors & handles
- Integrated sinks & faucets
- Custom faucet handles
- Built-in ovens & cabinets
- Shower bases & enclosures and plumbing fixtures
- Multiple sink countertop
- Medicine cabinets & mirrors
- Kitchen and bath accessories

CALL TOLL FREE

888.324.2003

Dimensions

Design Group Inc.

Active Objects

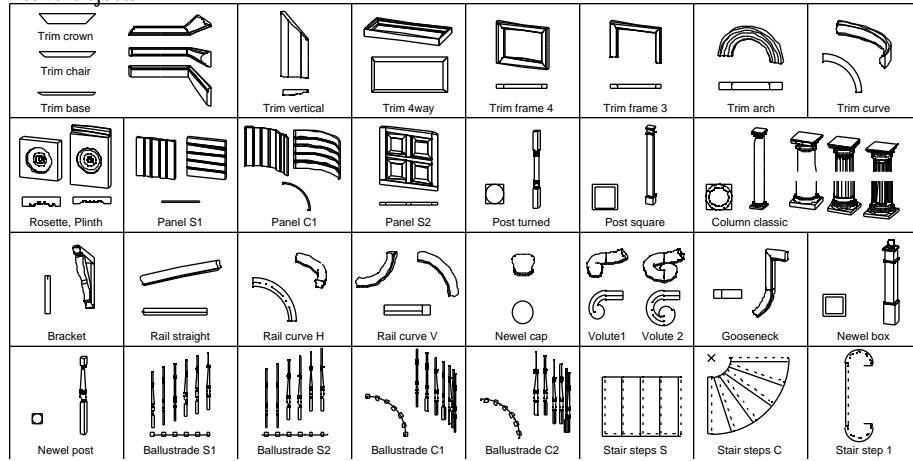

Macro Objects

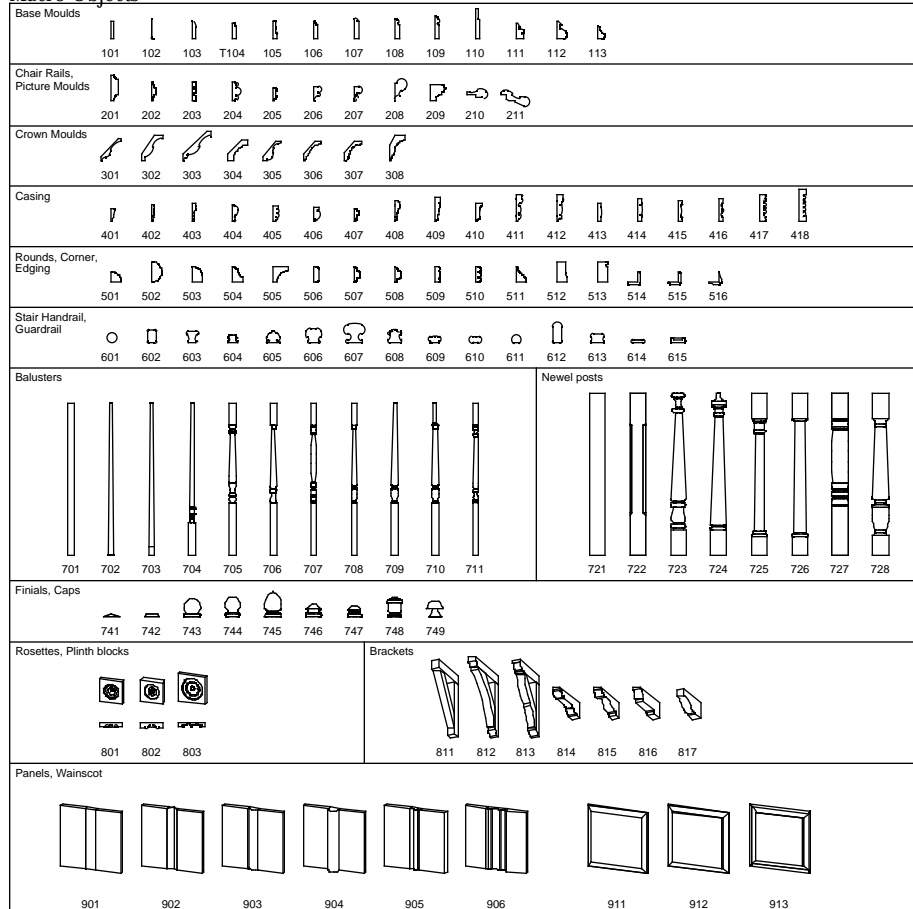

D3 SmartParts™ v3.0

TRIM Mouldings & Stairs



TRIM is a comprehensive set of over 170 parametric objects for refining interior and exterior models. Easy to use trim objects are stretchable and mitered for any configuration in 2D and 3D. Profiles conform to the standards of the millwork industry. Perfect for QuickTime VR presentations as well as elevations and sections in construction documents.

Features:

- NEW quick and easy custom moulding tool to create a profile anywhere in plan and miter both horizontally and vertically.
- Classical column can be cut any angle and has two base styles and three shaft styles including flutes.
- Over 60 standard trim shapes
- Full miter control for inside and outside corners and vertical angles
- Change trim profile styles without affecting size and orientation
- 3 levels of smoothness
- Trim one to four sides with one only part
- Straight, curved, spiral and arched trim
- Vertical trim frame with three or four sides for doors and artwork
- Rosettes and plinth blocks
- Stair steps - straight or curve - with optional round nosing and cove
- 15 railing, 11 Baluster and 8 newel post styles
- Open or closed stair treads
- Volute and gooseneck rail ends
- Wainscot with board & bead and raised panels
- Square and turned posts
- 7 Bracket styles

CALL TOLL FREE

888.324.2003

Dimensions

Design Group Inc.



D3 SmartParts™ v3.0 HOME Furniture



HOME Furniture adds an extra touch of realism to ArchiCAD models. Included in this set are a variety of flexible, parametric objects that can be used for most common residential and hospitality designs.

Features:

- Classic, everyday furniture for making your designed space feel "at home"
- Over 150 parametric objects for living, dining, and sleeping
- NEW 9 classic chairs for a total of 32 chairs - couches, love seats, chairs, stools and rockers
- NEW 5 tables for a total of 14 tables
- NEW lamps - table lamps, wall sconces and hanging
- Dining tables have adjustable tablecloth with complete dining place settings
- Four types of bed frames in standard sizes
- Clocks - grandfather, mantel, and wall - with definable time
- Upright piano and a baby grand piano that stretches to a concert grand
- Flowers in vases and plants in pots
- Framed pictures with user defined picture images
- Oriental rugs with four designs
- Outdoor furniture
- Electronic equipment - TVs with user defined picture images, stereo components, and speakers
- Build your own china cabinet or armoire using modular storage components including base, drawers, doors, and cap

CALL TOLL FREE

888.324.2003

Dimensions

Design Group Inc.

www.ddgi.com

OFFICE Furniture by DIMENSIONS ©1999

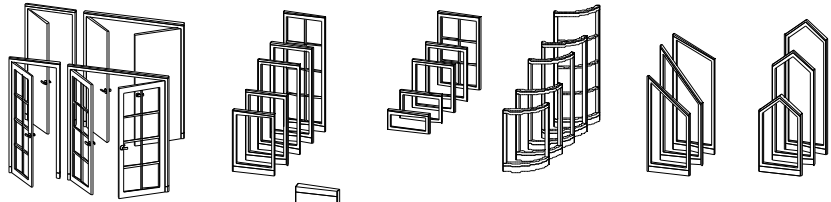

Modular Panel System

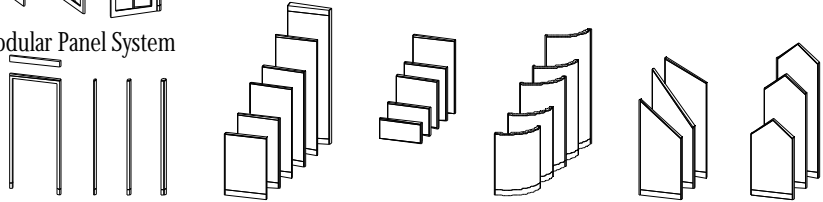

Modular Desk System

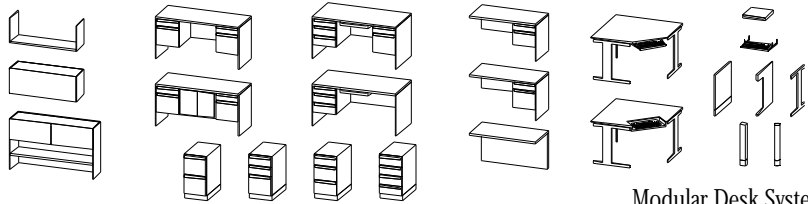

Modular Work Top System

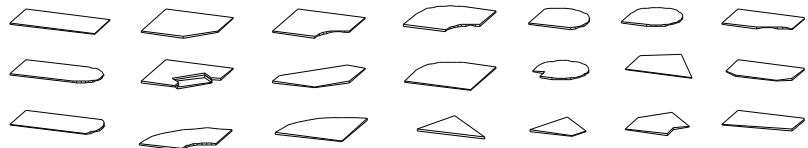

Office Seating

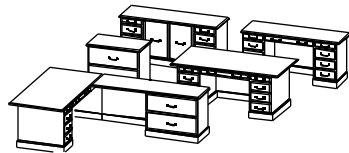

Traditional Desk System

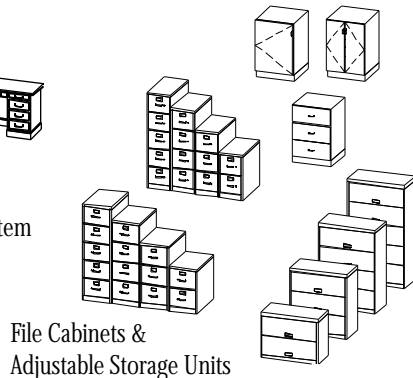

File Cabinets & Adjustable Storage Units

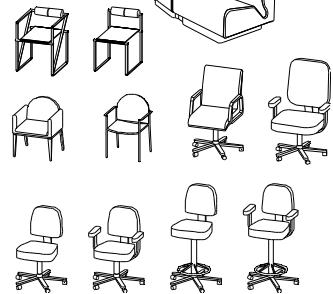

Desk Accessories

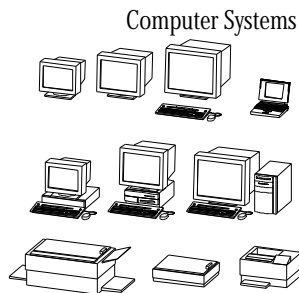

Computer Systems

D3 SmartParts™ v3.0 OFFICE Furniture

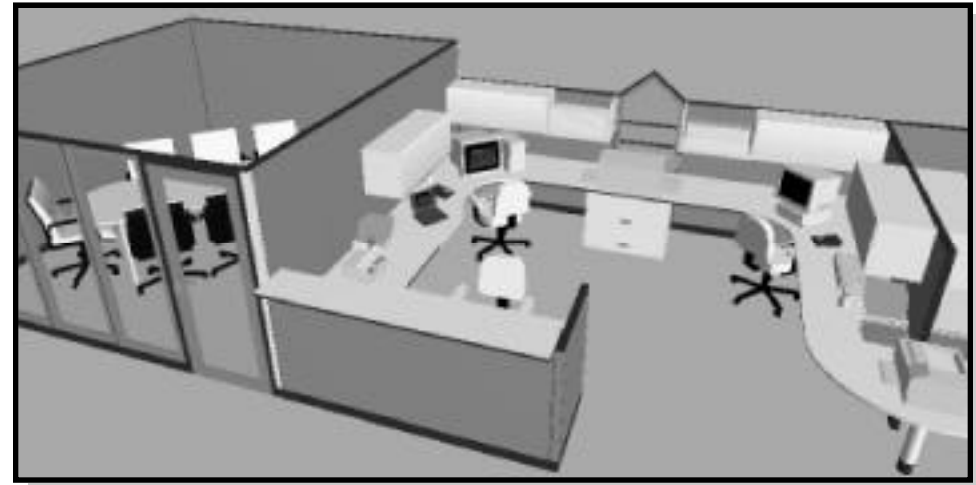

OFFICE Furniture set has components to layout and study all kinds of office environments. The modular systems have adjustable sizes and configurations that give the designer and facilities manager total flexibility.

Features:

- Over 130 parametric objects to outfit any size business environment
- NEW conference tables
- Traditional desks and credenzas
- Fully parametric modular wall panels to meet any manufacturer's office system, featuring curved, sloped and glass configurations with optional label code display
- Modular desktop systems for any shape or angle configuration
- File cabinets - lateral, letter and legal in all standard heights
- Shelves and door/drawer cabinets
- Task chairs
- Drafting chairs
- Executive chairs
- Side chairs
- Computers with parametrically configured monitors and keyboards
- Computer monitors have user-defined pictures for display
- Copier, fax, scanner, phone, and a variety of desk accessories

CALL TOLL FREE

888.324.2003

Dimensions

Design Group Inc.

www.ddgi.com

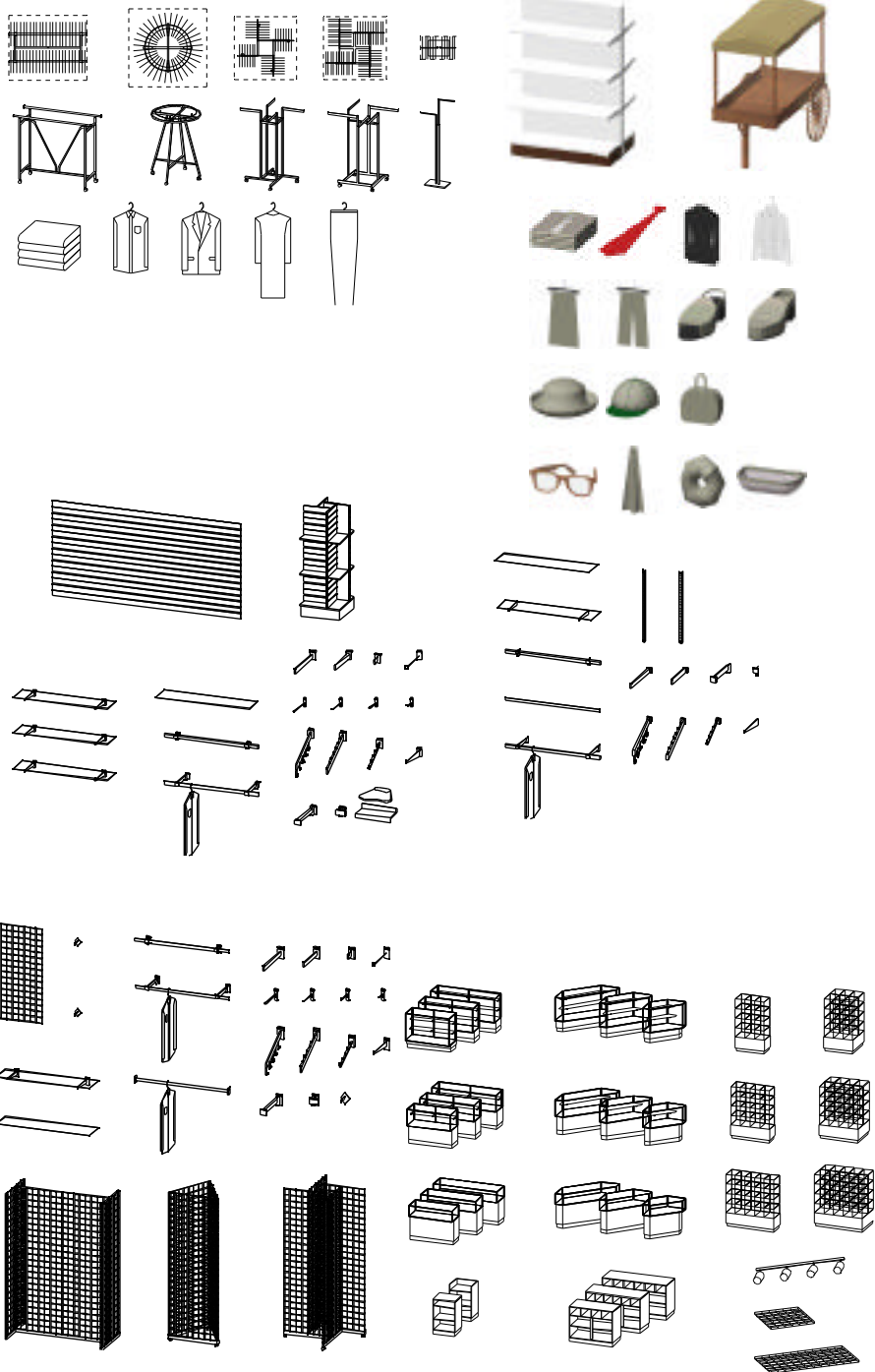

D3 SmartParts™ v3.0 STORE Planner



Select from dozens store fixtures commonly used in retail projects. Add details like shirts on racks or faceouts. Adjust number of shelves by easy parameter changes. Test a variety of layouts to maximize a store's potential.

Features:

- NEW gondola display rack with adjustable shelves.
- NEW clothes and accessories.
- Parametric 2D plan symbols
- Fully operable racks
- Optional clothes display
- Slatwall system
- Gridwall system
- Standards and brackets
- Four-way racks
- Super Quad racks
- Two-way rack
- Straight and round racks
- Display cabinets
- Cashwrap cabinets
- Faceouts, Waterfalls, Hooks
- Track lights
- Spot lights
- Fluorescent lights
- Shelving system
- Hangrod system
- Shoe shelf
- Glass shelf system

CALL TOLL FREE

888.324.2003

Dimensions

Design Group Inc.

www.ddgi.com